

6 Stepping motor control amplifier board series SE...V3 and SE...E50 V3

Stepper motor power amplifier board series SE...V31 / SE...V33

- Bipolar 2-Phases-stepper motor power amplifier
- Compatible with STÖGRA / Zebotronics standard units SE ... (e.g. SE 400.06.85), SE... B... , SE...V11 / SE...V13 and SE...V21 / SE...V23
- Protected against short circuit, over temperature and under voltage
- Via DIP-switch selectable step resolutions: 200, 400, 500, 800 and 1000 steps per revolution
- Via DIP-switch selectable input signal levels High-active TTL or High-active PLC or Low-active
- For version SE... E50.. with encoder input for control of load angle (at connection of a stepper motor with encoder E50)

Dimensions

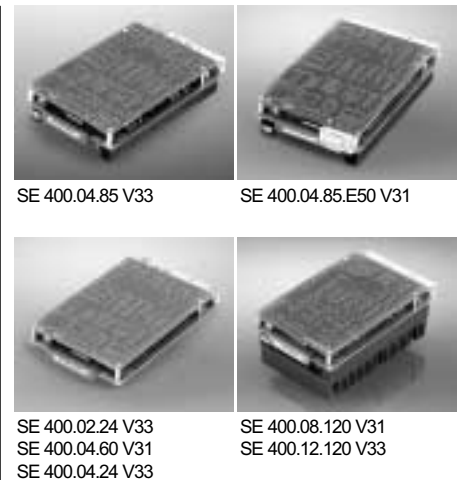
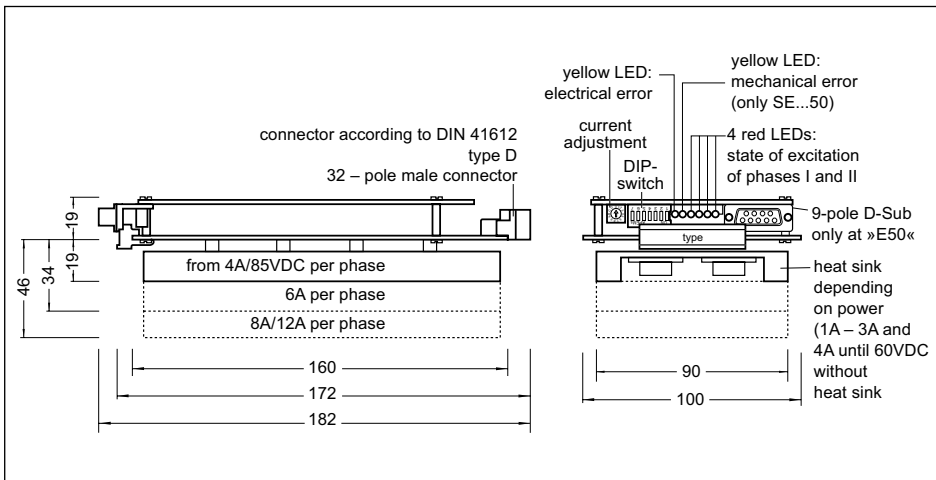

Dimensions series SE... V31/33

Adjustements via solder bridges

marker	notes	standard adjustment
M	open: enable output of a mechanical error closed: disable output of a mechanical error	E50 board open, else closed
F	internal function (do not change!)	closed
H	internal function (do not change!)	open

Selections of step resolution

X = switch in ON-position

W2	W1	W0	steps/rev.
			800
		X	400
	X		1000
	X	X	500
X			400
X		X	200
X	X		not valid
X	X	X	not valid

Automatical phase current reduction (switch »R«)

If switch »R« = OFF, then the phase current will be reduced by 50% at motor stand still. The first coming pulse at the pulse input will rise the phase current again to 100%. In case of an active reset signal the current reduction will not be activated.

M-function / double step (switch »M«)

If switch »M« = ON, then each signal edge at the pulse input will execute one motor step (the rising edge and the falling edge will execute one motor step each)

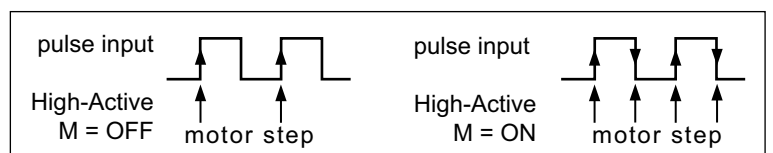

Stepping motor control amplifier board series SE...V3 and SE...E50 V3 7

Adjustment of phase current

Ex work the power amplifier board is set to its nominal current. The phase current must be adjusted depending on the connected stepper motor. The adjustment is done via the rotative switch at the boards front side according to below table. The values in the table correspond to the bipolar phase current of the motors.

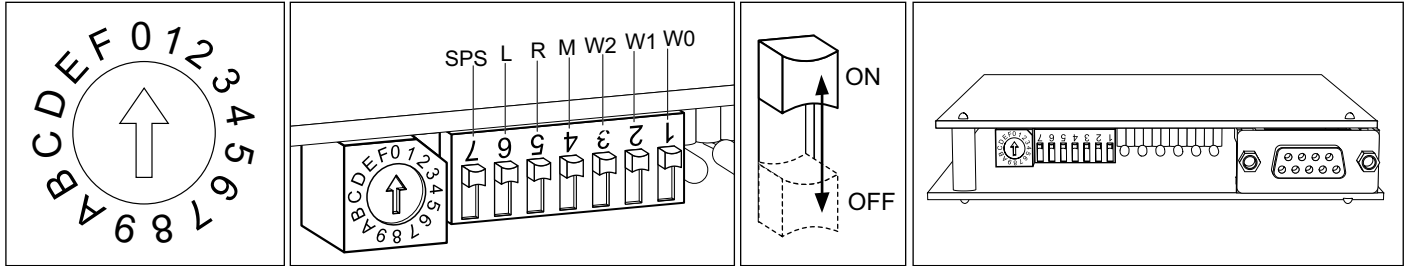

figure 3 to 4: phase current adjustment and selections via DIP-switch

phase current [A] nominal current / type	position of switch															
	0	1	2	3	4	5	6	7	8	9	A	B	C	D	E	F
1 A/Ph. SE ...01...	0,00	0,09	0,19	0,28	0,37	0,47	0,56	0,65	0,75	0,84	0,93	1,03	1,12	1,21	1,31	1,40
2 A/Ph. SE ...02...	0,00	0,18	0,38	0,56	0,74	0,94	1,12	1,30	1,49	1,68	1,86	2,06	2,24	2,42	2,62	2,80
3 A/Ph. SE ...03...	0,00	0,26	0,56	0,84	1,12	1,40	1,68	1,96	2,24	2,52	2,80	3,08	3,38	3,64	3,92	4,20
4 A/Ph. SE ...04..	0,00	0,36	0,76	1,12	1,48	1,88	2,24	2,60	2,98	3,36	3,72	4,12	4,48	4,84	5,24	5,60
6 A/Ph. SE ...06...	0,00	0,56	1,12	1,68	2,24	2,80	3,36	3,92	4,48	5,04	5,60	6,16	6,72	7,28	7,84	8,40
8 A/Ph. SE ...08...	0,00	0,48	1,68	2,52	3,36	4,20	5,04	5,88	6,72	7,56	8,40	9,24	10,1	10,9	11,8	12,6
12 A/Ph. SE ...12...	0,00	0,96	1,92	2,88	3,84	4,80	5,76	6,72	7,68	8,64	9,60	10,6	11,5	12,5	13,4	14,4

Input signals – selection of signal level

switch position	L = OFF and SPS = OFF	L = ON and SPS = OFF	L = OFF and SPS = ON	L = ON and SPS = ON
signal level	High-active TTL-level	Low-active	High-active SPS-level	not valid

Output – ready signal

SE... [E50] V31 and SE... [E50] V33:

ready signal: Indication of an electrical error or a mechanical error (at SE...E50 V...).
In non error state the relay contact is closed

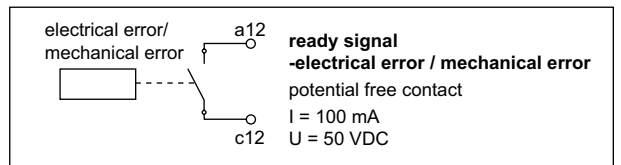

output – ready signal

Input signals

- Boost:** Rise of phase current by 20%
- Disable:** Disable motor phases – phase current is switched off
- Reset:** Drive errors are reset, drive in reset position (phase zero), pulse signals are disabled
- Direction:** Control of motor direction
- Pulse:** Each pulse executes one motor step
- Step Angle:** Switches step resolution from 1000 to 500 or 800 to 400 or 400 to 200 steps per revolution
The signal is always Low-Active and will work only at switch W0 in OFF-position.
- Ready signal:** (see fig. 5 and 6) indicates an **electrical error** (under voltage, short circuit or over temperature) respective **error mechanical** (only for SE...E50..). In non-error condition the relay contact is closed.

Input signals HIGH-active

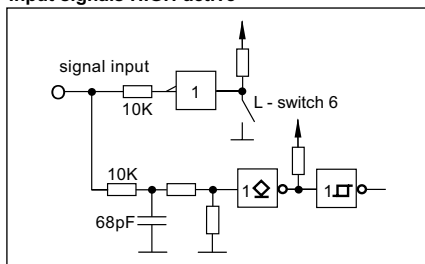

Input signals PLC – level

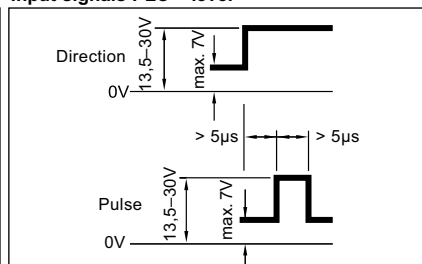

Input signals TTL – level

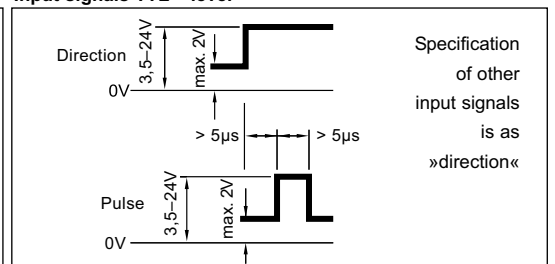

signal rise time max.: 1µs, signal fall time max.: 1µs, frequency pulse max.: 45 KHz

8 Stepping motor control amplifier board series SE...V3 and SE...E50 V3

Technical specifications

protection of the device	protection class IP00, protection against short circuit, over temperature and under voltage					
weight	nominal current [A/Ph]	1 – 3	4	6	8	12
	weight [Kg]	0,2	0,52	0,77	1,1	1,1
voltage supply	version	24	60	85	120	240
	range [VDC]	20 – 40	40 – 70	50 – 85	60 – 120	120 – 240
ambient conditions	ambient temperature: 0°C to 50°C, max. sink temperature: 85°C, forced draft: for amplifier boards with nominal current with 12A					
noise immunity	in case of correct installation: according to EN50082-2: – at selection TTL-signal level (switch SPS = OFF) the inputs are not immune against fast transients (burst)					
noise radiation	in case of correct installing and shielding or / and filtering of the lines and signals according to EN55011 class B					
RoHs conformdirective to 2002/95/EC						

Connections

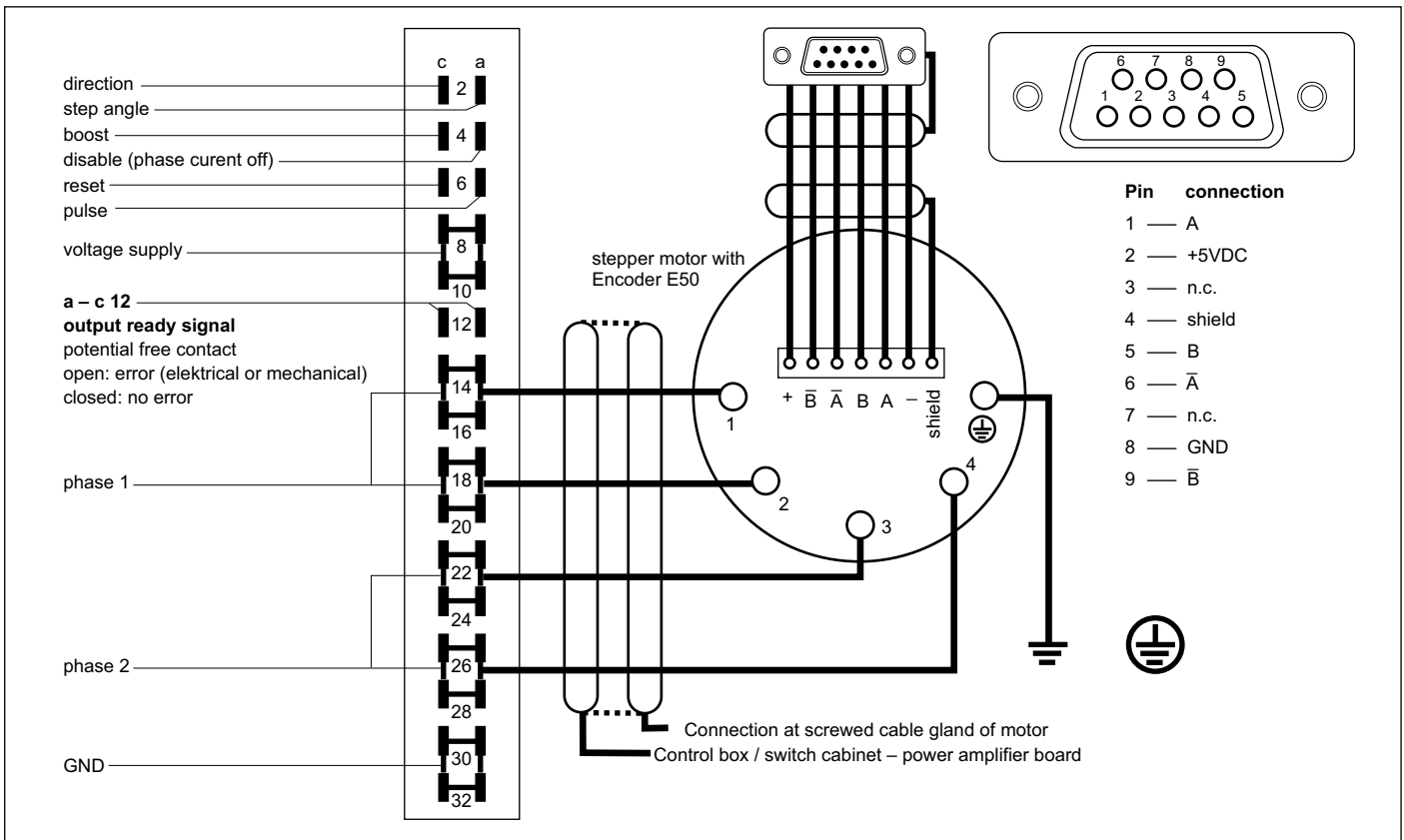

Ordering key: Example: SE 800.06.120 E50 V33 or SE 1000.04.85 V31

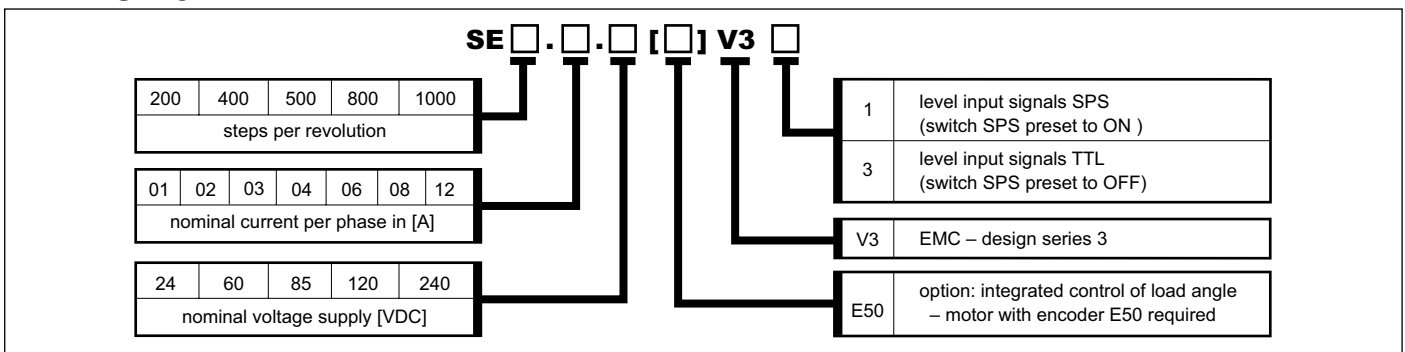

Restriction in possible combinations: 1A, 2A and 3A only with 24VDC and 60VDC, 240VDC only with 8A and 12 A

- Step resolution adjustable from 200 to 12800 steps / rev. and externally switchable
- Excellent truth micro stepping over the entire velocity range
- Electrically and mechanically compatible to standard amplifier (SE...V...)
- Shortcircuit, overtemperature and undervoltage protected
- Voltage range from 24VDC to 240VDC
- Phase current versions from 0 A / phase to 14,5 A / phase
- Constant torques for all pre-selected resolutions



SE P05...V2 Microstep

Step angle adjustment on the board

Different step angles can be selected via the switches C0, C1, C2 and C3. With the input »step angle« (Pin a2) the step angle can be switched externally between two values (switch »W« must be open!). During motion, switching the step angle is possible within the motor start-stop-frequency (when changing simultaneously the pulse frequency and step angle – at any frequency).

steps / revolution resolution switchable externally – PIN a2		Marker for step angle selection X = switch closed, else = switch open			
not active	active	C3	C2	C1	C0
2000	200	X	X	X	X
	400	X	X	X	
2500	500	X	X		X
3200	800	X	X		
4000	400	X		X	X
	800	X		X	
	1000	X			X
5000	500	X			
	1000		X	X	X
8000	800		X	X	
	2000		X		X
10000	400		X		
	1000			X	X
12800	2000			X	
	800				X
	1600				X

There are further step angles available! Please ask at our sales office.

Adjustments via DIP-switches at the front side of the control board:

switch	denotes	
S0	phase current characteristics	further specifications: dimensions, input signals, output signals, phase current adjustment, voltage supply, general technical specifications as SE... V31/V33
C0 – C3	selection of step angle (see table above)	
W	activates row »Pin a2 active« of above step angle table »Pin a2 active« (external switching of step angle) is deactivated	
SPS	open: »TTL« – input level closed: »SPS – input level (PLC signal level)	
R	automatic current reduction (see SE...V3... page 6)	
L	open: signals High-Active – closed: signals Low-Active	

selectable adjustments

Available versions: (e.g.: SE P05.06.85 V2)

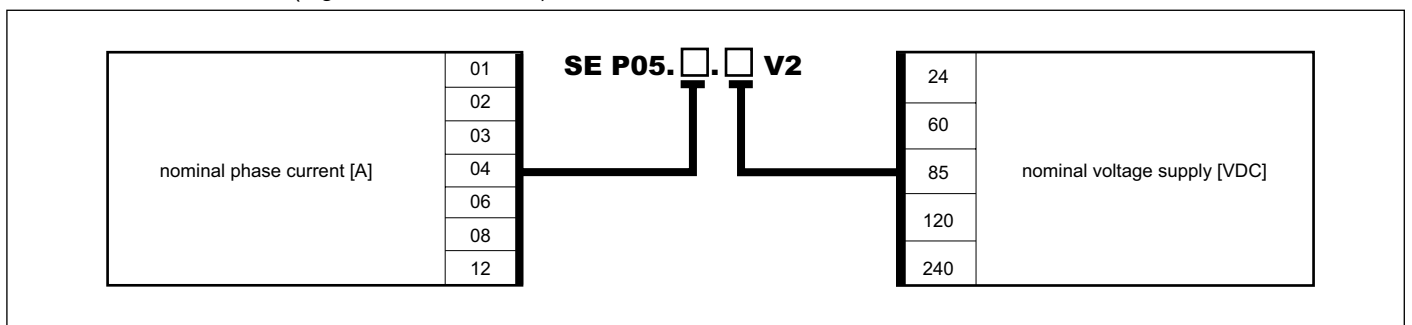

Restriction in possible combinations: 1A, 2A and 3A only with 24VDC and 60VDC, 240VDC only with 8A and 12 A